

Patternübersicht



Western Riding

LK 1-2 A/B Pattern 4

LK 3 A/B Pattern 8

Senior Superhorse

LK 1-2 A/B Pattern 1

Reining

LK 1-2 A/B Pattern 11

LK 3 A/B Pattern 5

LK 4 A/B Pattern 14

Ranch Riding

LK 1 A/B Pattern 6

LK 2 A/B Pattern 6

LK 3 A/B Pattern 2

LK 4 A/B Pattern 3

LK 5 A/B Pattern 3

Trail Horse LK 1 A / LK 1 B

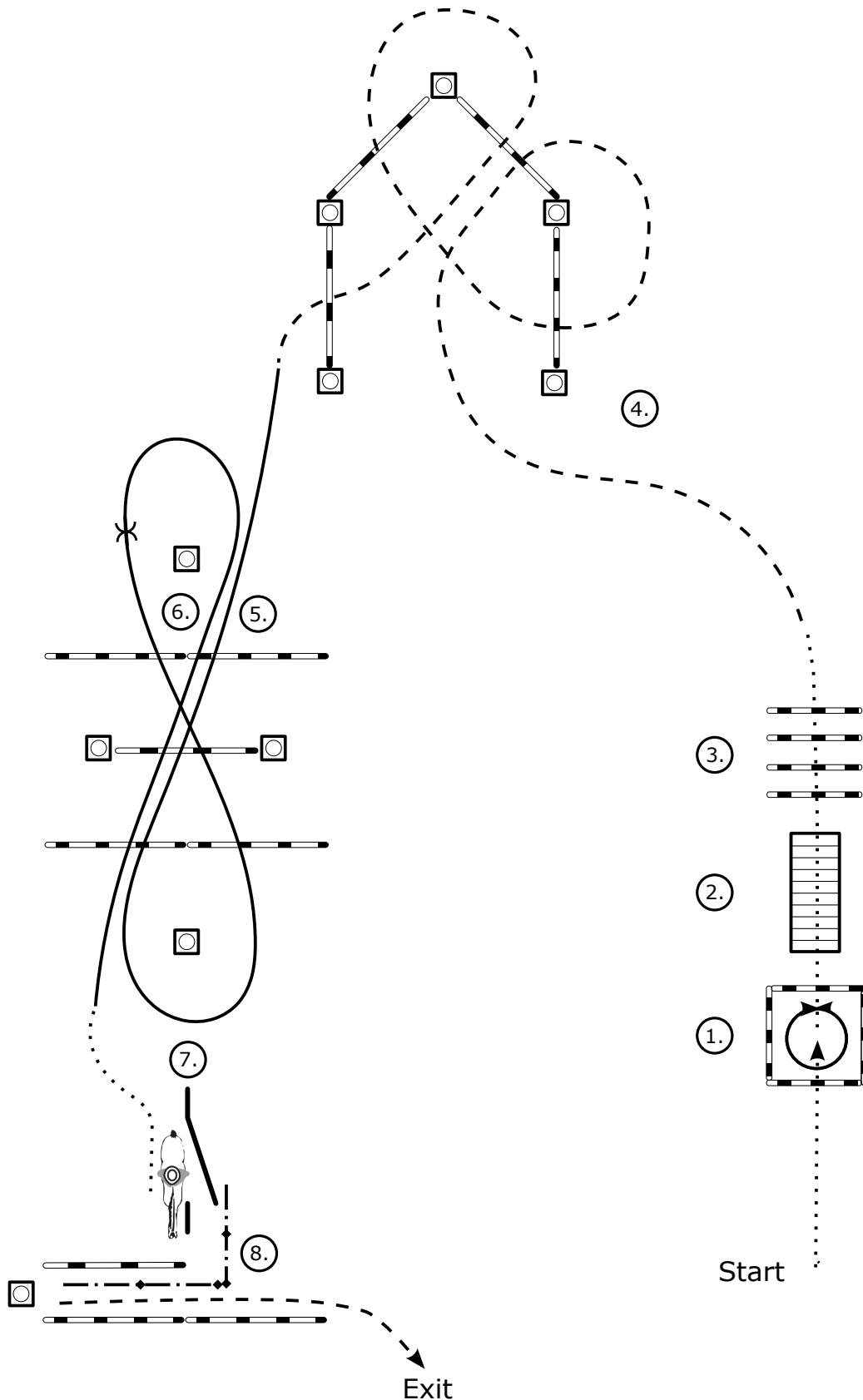

1. 360° Turn (L or R)
 2. Bridge
 3. Walk Overs
 4. Jog Overs
 5. Lope (LL) Overs
 6. Lead Change (fly/simple)
Lope (RL) Overs
 7. Gate (LH)
 8. Back Up
- Jog to Exit

LH = Left Hand
 RH = Right Hand
 LL = Left Lead
 RL = Right Lead

Start

- Schritt
- - - - - Trab
- Galopp
- ◄ - - - - - ► Rückwärts
- no ► Seitwärts
- X — Galoppwechsel

Trail Horse LK 2 A / LK 2 B

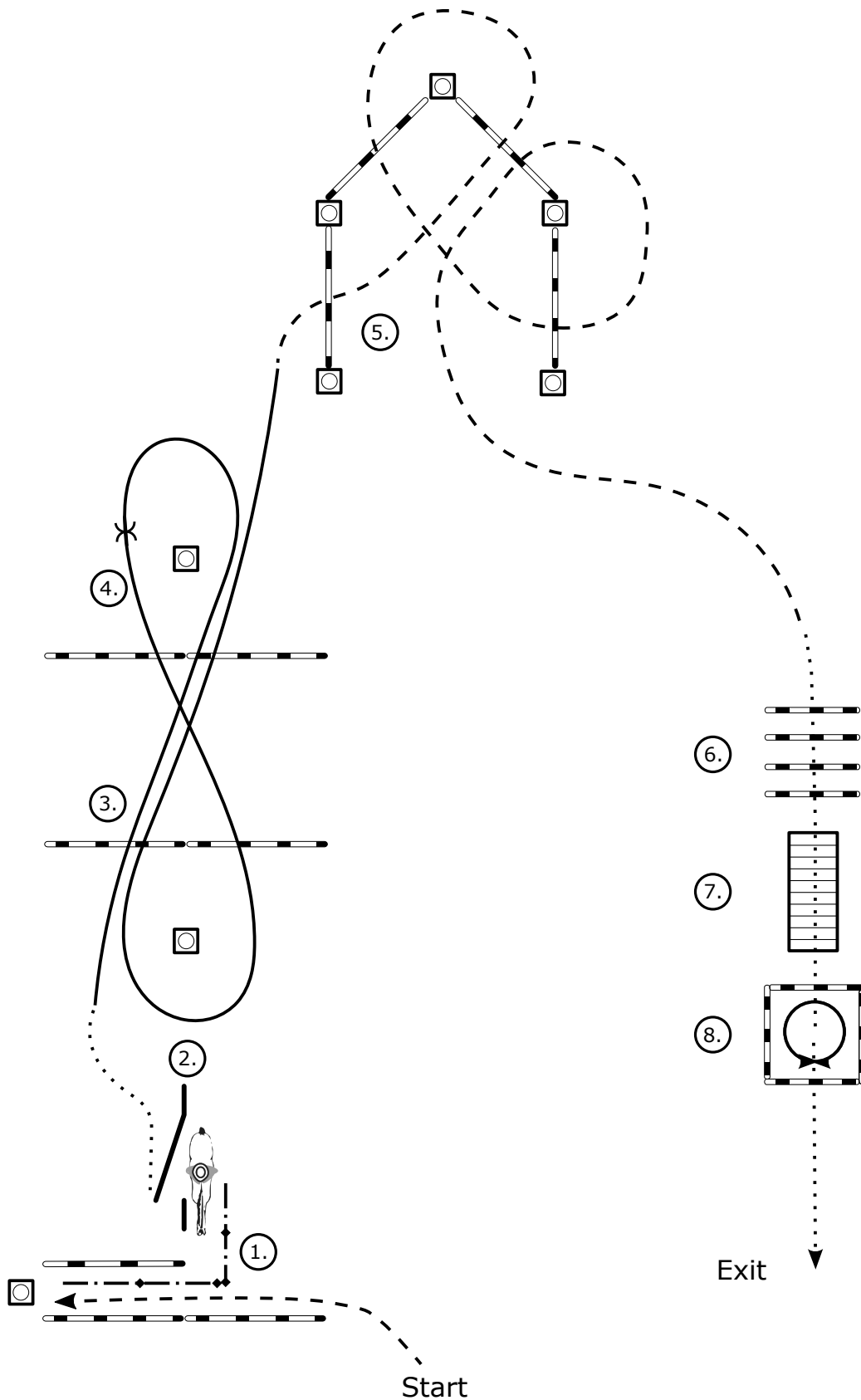

1. Jog into Chute
Back Up
2. Gate (RH)
3. Lope (LL) Overs
4. Lead Change (fly/simple)
Lope (RL) Overs
5. Jog Overs
6. Walk Overs
7. Bridge
8. 360° Turn (L or R)

Walk out to Exit

LH = Left Hand
 RH = Right Hand
 LL = Left Lead
 RL = Right Lead

- Schrittl
- - - - - Trab
- Galopp
- ◆ — ◆ — ◆ — Rückwärts
- no> Seitwärts
- X — Galoppwechsel

Trail Horse LK 5 A/B

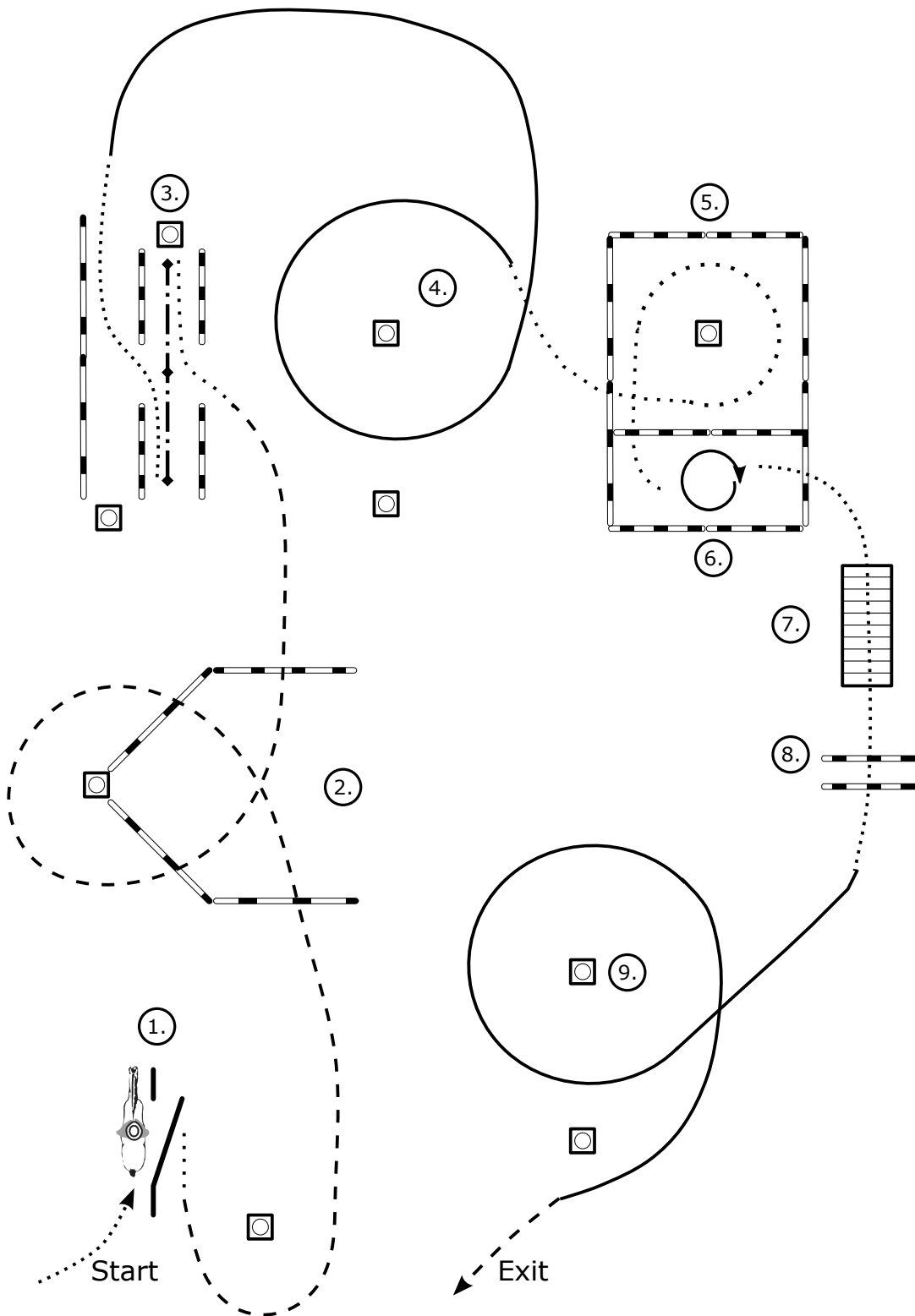

1. Gate (RH)
2. Jog Overs
3. Back Up
4. Lope (RL) Circle
5. Walk around Marker
6. 360° Turn (R)
7. Bridge
8. Walk Overs
9. Lope (RL) Circle

Jog to Exit

LH = Left Hand
 RH = Right Hand
 LL = Left Lead
 RL = Right Lead

- Schritt
- - - - - Trab
- Galopp
- ◆ — ◆ — ◆ — ◆ — ◆ Rückwärts
- no> Seitwärts
- X — Galoppwechsel

Ranch Trail LK 1-3

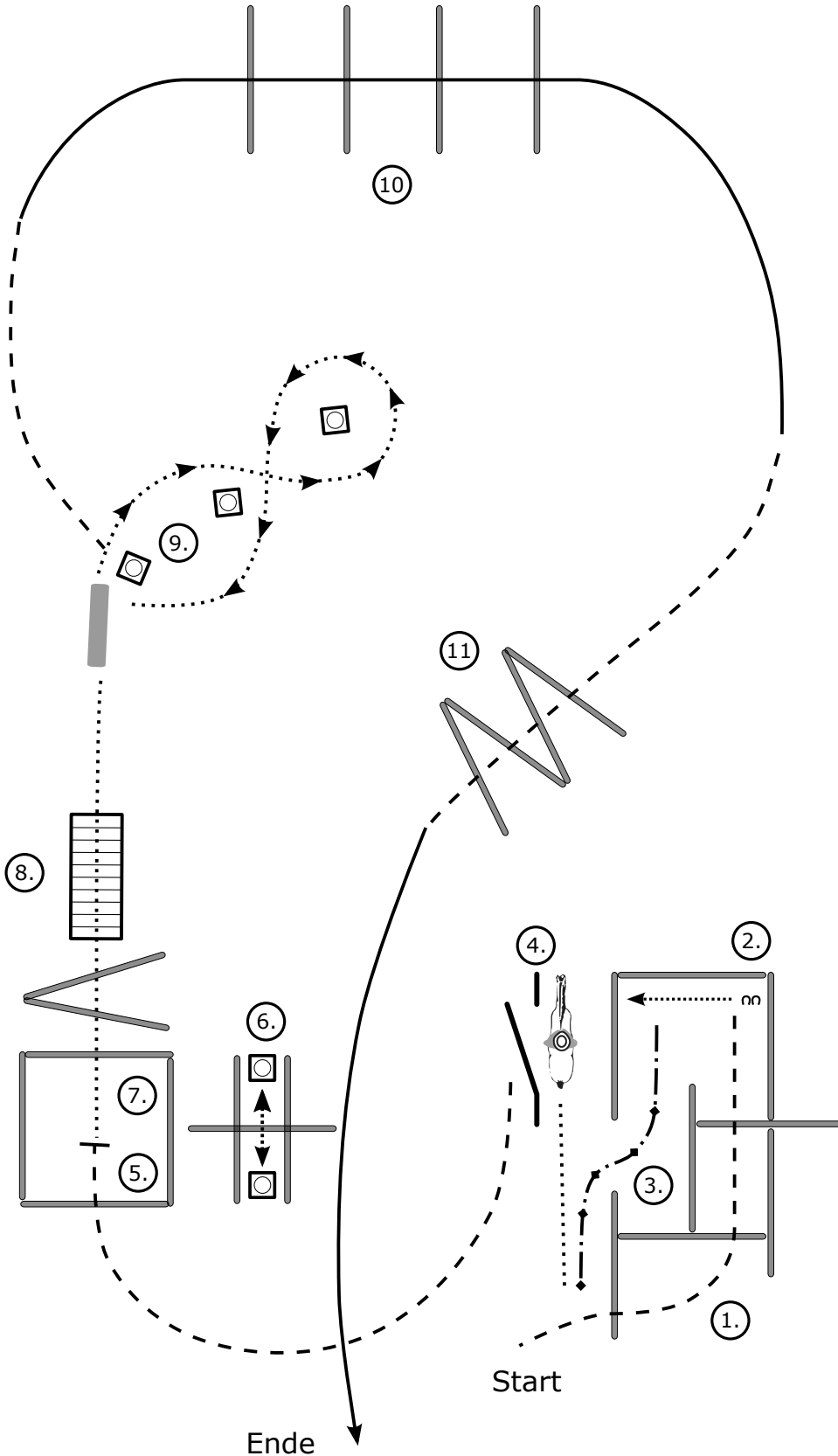

1. Jog Overs
2. Sidepass (L)
3. Back Up
4. Gate (LH)
5. Ground Tie
6. Log Roll
7. Aufsitzen
Walk Overs
8. Bridge
9. Log Drag
10. Lope (RL) Overs
11. Jog Overs

Lope Out

LH = Left Hand
 RH = Right Hand
 LL = Left Lead
 RL = Right Lead

- Schritt
- - - - - Trab
- Galopp
- ◄-----► Rückwärts
- ↔ Seitwärts
- ⌘ Galoppwechsel

Ranch Trail LK 4/5

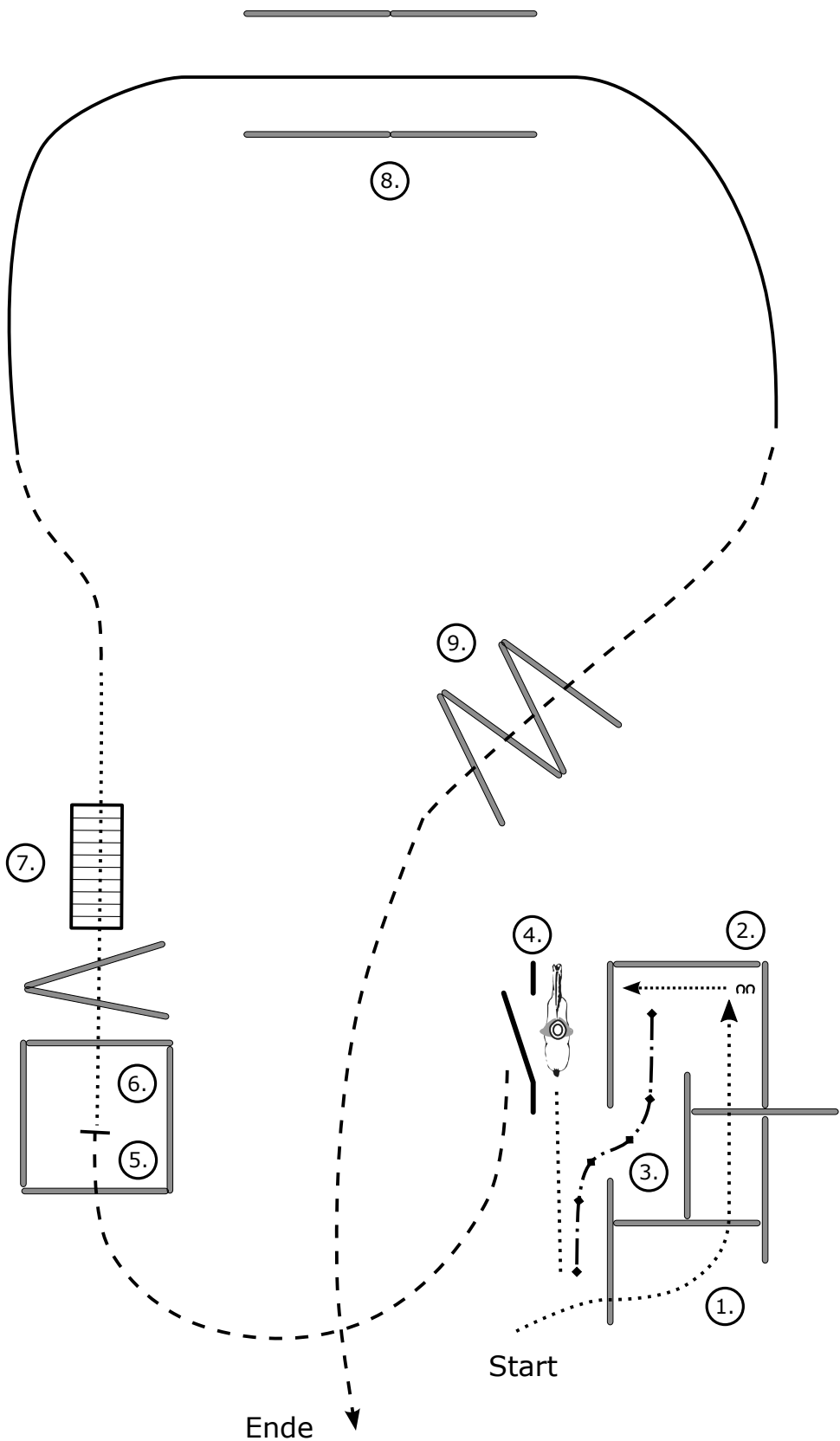

1. Walk Overs
2. Sidepass (L)
3. Back Up
4. Gate (LH)
5. Hufe hochheben
6. Aufsitzen
Walk Overs
7. Bridge
8. Lope (RL) thru
9. Jog Overs

Jog Out

LH = Left Hand
RH = Right Hand
LL = Left Lead
RL = Right Lead

- Schritt
- - - - - Trab
- Galopp
- ◄ - - - - - ► Rückwärts
- nn ► Seitwärts
- X — Galoppwechsel

Showmanship at Halter LK 1-2 A/B

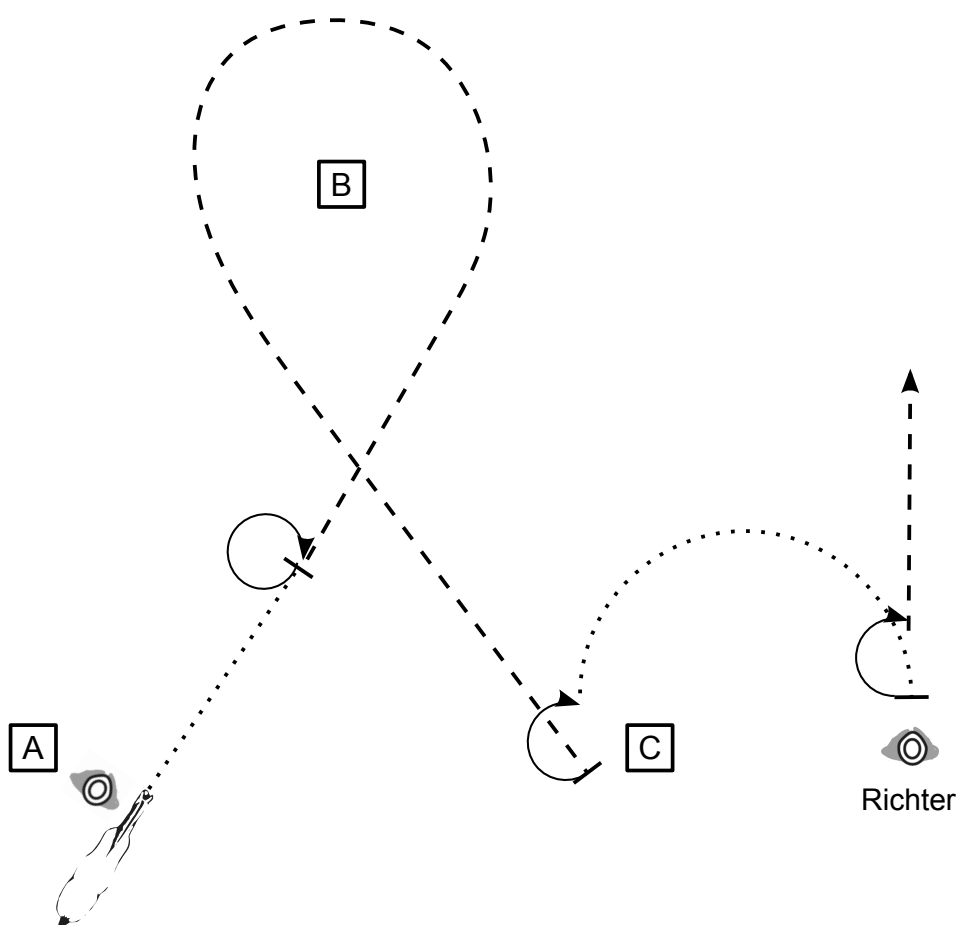

Set Up bei A

1. Walk den halben Weg bis B - Stop
2. 360° Turn
3. Jog zu und um B bis C - Stop
4. 225° Turn
5. Walk einen halben Zirkel bis zum Richter - Stop
6. Set Up
7. 180° Turn

Jog weg vom Richter

- A Marker
 Schritt
 - - - - - Trab
 - - - - - ext. Trab
 ←↻→ Rückwärts

Showmanship at Halter LK 3-4 A/B

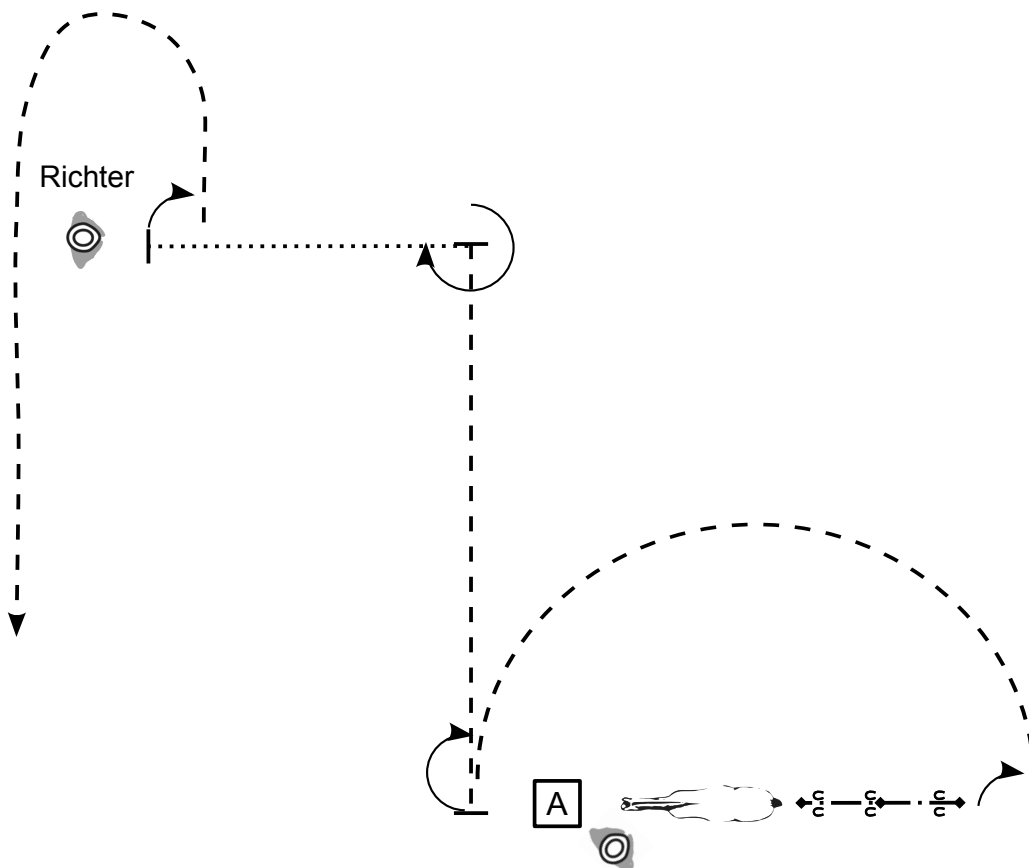

Set Up vor A

1. Ca. 2 Pferdelängen Back Up
2. 90° Turn
3. im Jog zurück zu A - Stop
4. 180° Turn
5. im Jog bis auf Höhe de Richters - Stop
6. 270° Turn
7. im Walk zum Richter - Stop
8. Set Up
9. 90° Turn

Im Jog gerade weg vom Richter und in die Warm Up Area

- A Marker
- Schritt
- - - - - Trab
- - - - - ext. Trab
- ← 2 → · → 3 → · → 3 → Rückwärts

Western Horsemanship LK 1 A / LK 1 B

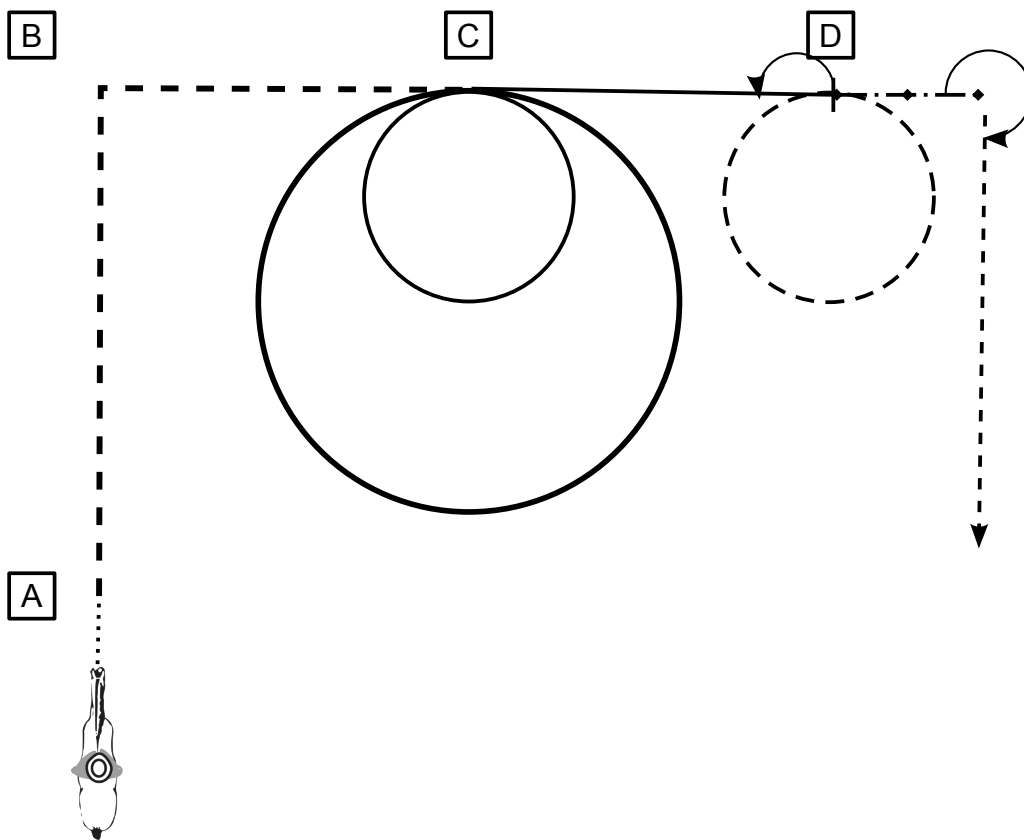

1. Walk bis A
Ext. Jog bis C
2. bei C Lope (RL) 2 Zirkel
+ 1. klein und langsam
+ 2. groß und schnell
+ im Lope bis D - Stop
3. 180° Turn (L)
4. Jogzirkel (L) bei D - Stop
5. Back Up
6. 270° Turn (R),

Im Jog zurück in Richtung zur Warm Up Area

L = Left
 R = Right
 LL = Left Lead
 RL = Right Lead

- A** Marker
- Schritt
 - - - - - Trab
 - - - - - ext. Trab
 - Galopp
 - ext. Galopp
 - ◄ - - - - ► Rückwärts
 - on → Seitwärts
 - X — Galoppwechsel

Western Horsemanship LK 2 A / LK 2 B

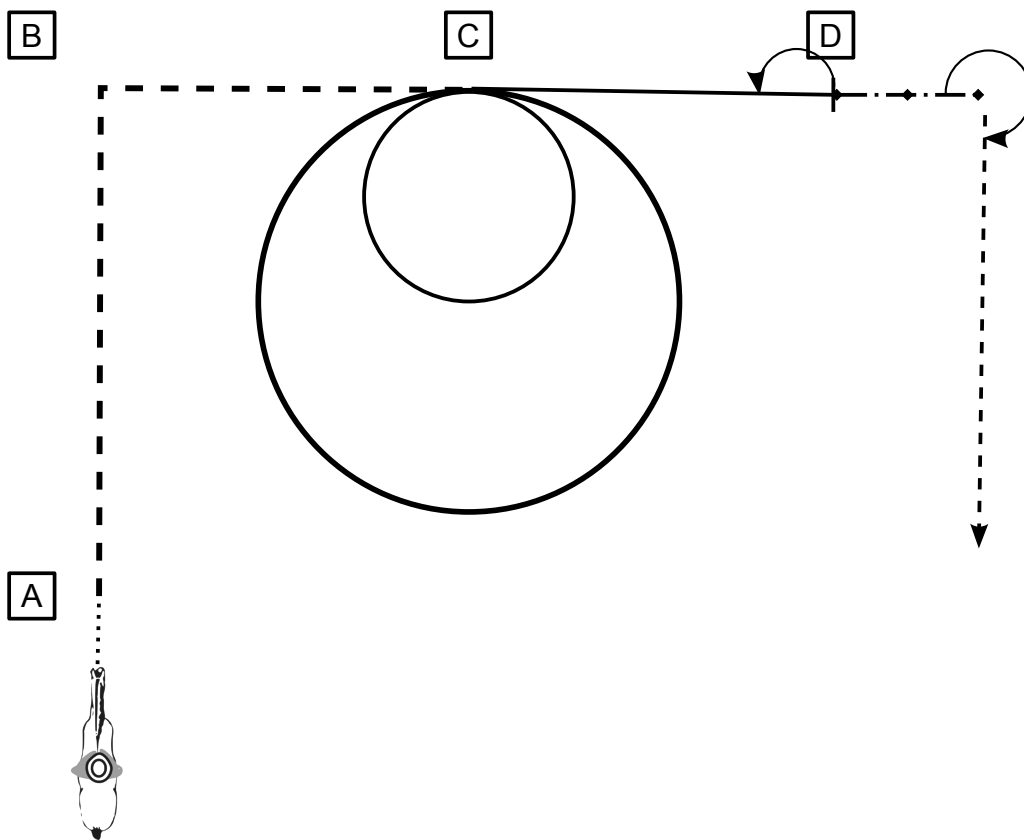

1. Walk bis A
Ext. Jog bis C
2. bei C Lope (RL) 2 Zirkel
+ 1. klein und langsam
+ 2. groß und schnell
+ im Lope bis D - Stop
3. 180° Turn (L)
4. Back Up
5. 270° Turn (R),

Im Jog zurück in Richtung zur Warm Up Area

L = Left
 R = Right
 LL = Left Lead
 RL = Right Lead

- A** Marker
- Schritt
 - - - - - Trab
 - - - - - ext. Trab
 - Galopp
 - ext. Galopp
 - ◄ - - - - - ► Rückwärts
 - nn → Seitwärts
 - X — Galoppwechsel

Western Horsemanship LK 3 A

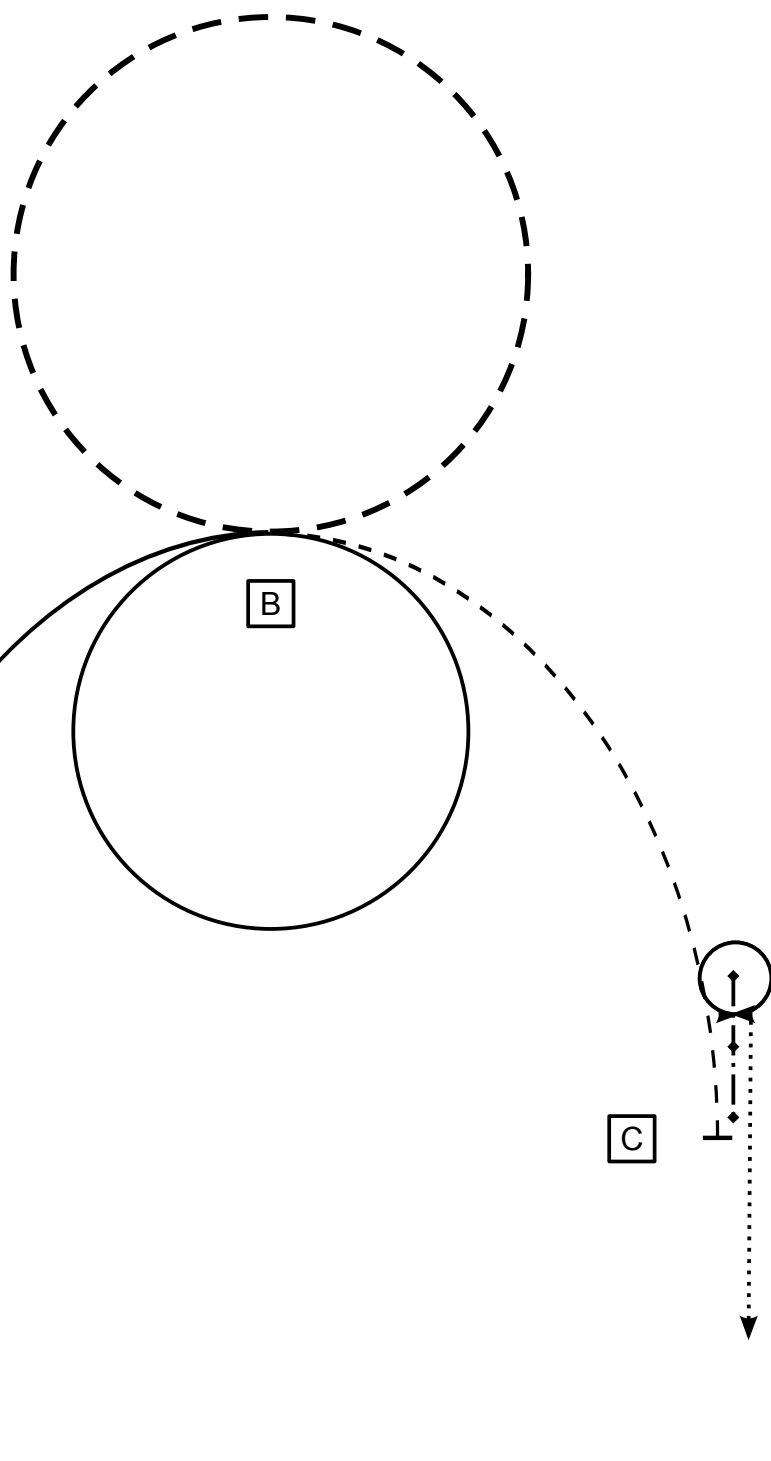

1. Walk zu A
bei A Lope bis B
2. bei B Lope (RL) Zirkel
3. bei B ext. Jog (L) Zirkel
4. bei B Jog zu C - Stop
5. Back Up
6. 360° Turn (R or L)

Im Walk zurück in die Warm Up Area

L = Left
 R = Right
 LL = Left Lead
 RL = Right Lead

- A** Marker
- Schritt
 - - - - - Trab
 - - - - - ext. Trab
 - Galopp
 - ext. Galopp
 - ◄ - - - - - ► Rückwärts
 - on> Seitwärts
 - X — Galoppwechsel

Western Horsemanship LK 4 A / LK 3-4 B



1. Walk zu A
bei A Jog bis B
2. bei B ext. Jog (L) Zirkel
3. bei B Lope (RL) Zirkel
4. bei B Jog zu C - Stop
5. Back Up
6. 360° Turn (R or L)

Im Walk zurück in die Warm Up Area

L = Left
 R = Right
 LL = Left Lead
 RL = Right Lead

- | | |
|-------------|---------------|
| A | Marker |
| | Schritt |
| - - - - - | Trab |
| - - - - - | ext. Trab |
| ————— | Galopp |
| ————— | ext. Galopp |
| ◄- - - - -► | Rückwärts |
| on> | Seitwärts |
| —————X————— | Galoppwechsel |

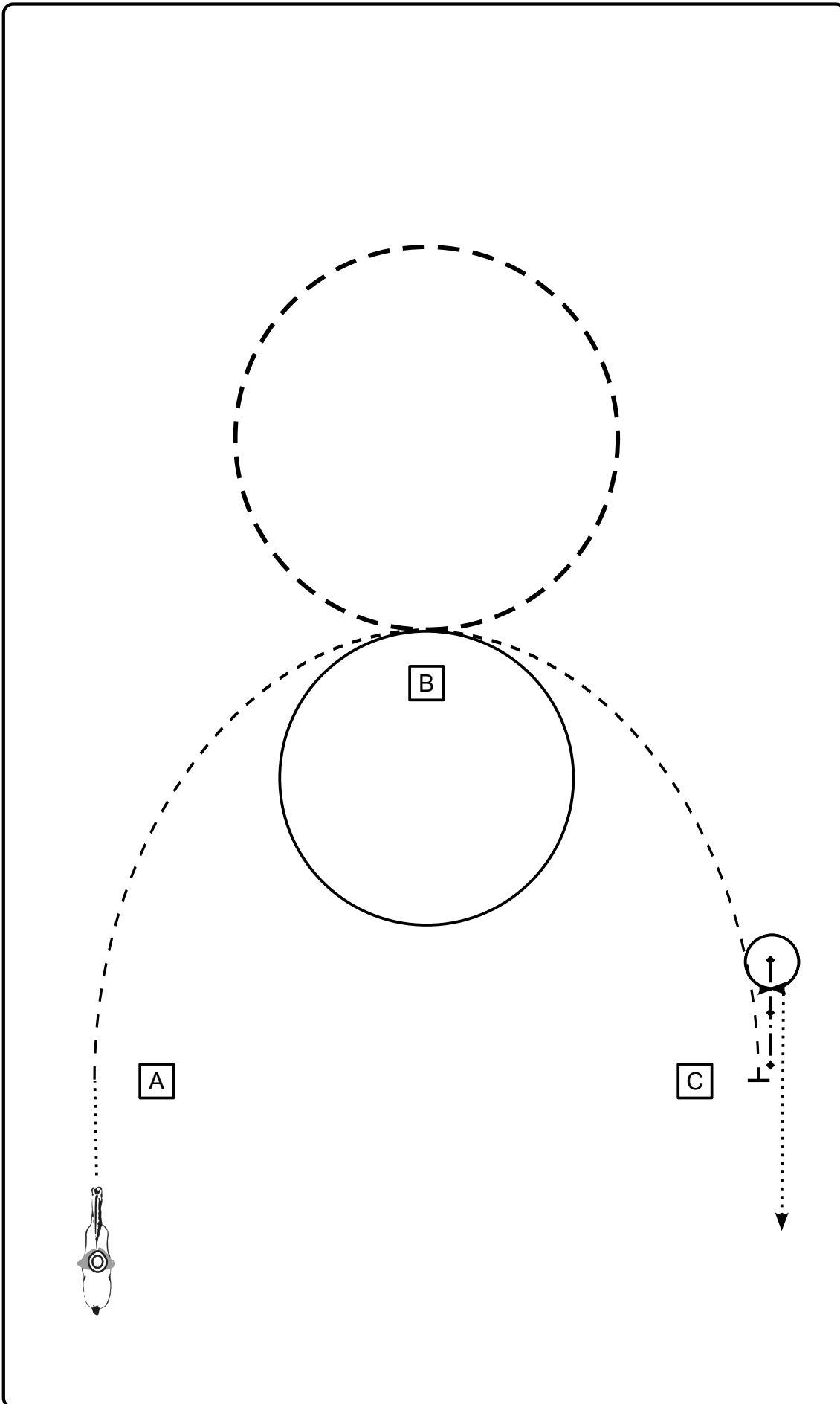

Western Horsemanship LK 5 A/B

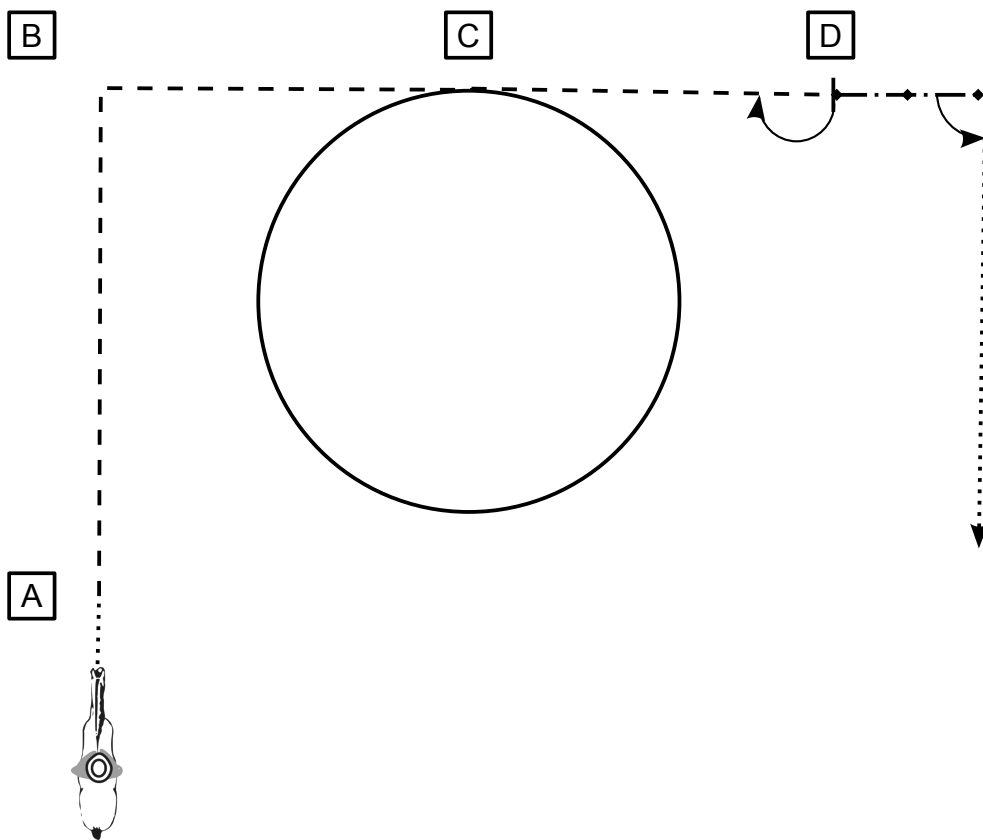

1. Walk bis A
Jog bis C
2. bei C Lope (RL) Zirkel
3. Jog bis D - Stop
4. 180° Turn (R)
5. Back Up
6. 90° Turn (L)

Im Walk zurück in die Warm Up Area

L = Left
 R = Right
 LL = Left Lead
 RL = Right Lead

- | | |
|-------------|---------------|
| A | Marker |
| | Schritt |
| - - - - - | Trab |
| - - - - - | ext. Trab |
| ————— | Galopp |
| ————— | ext. Galopp |
| ◆ - - - ◆ | Rückwärts |
| on | Seitwärts |
| ————— X ——— | Galoppwechsel |

Horse & Dog Trail LK 1-2

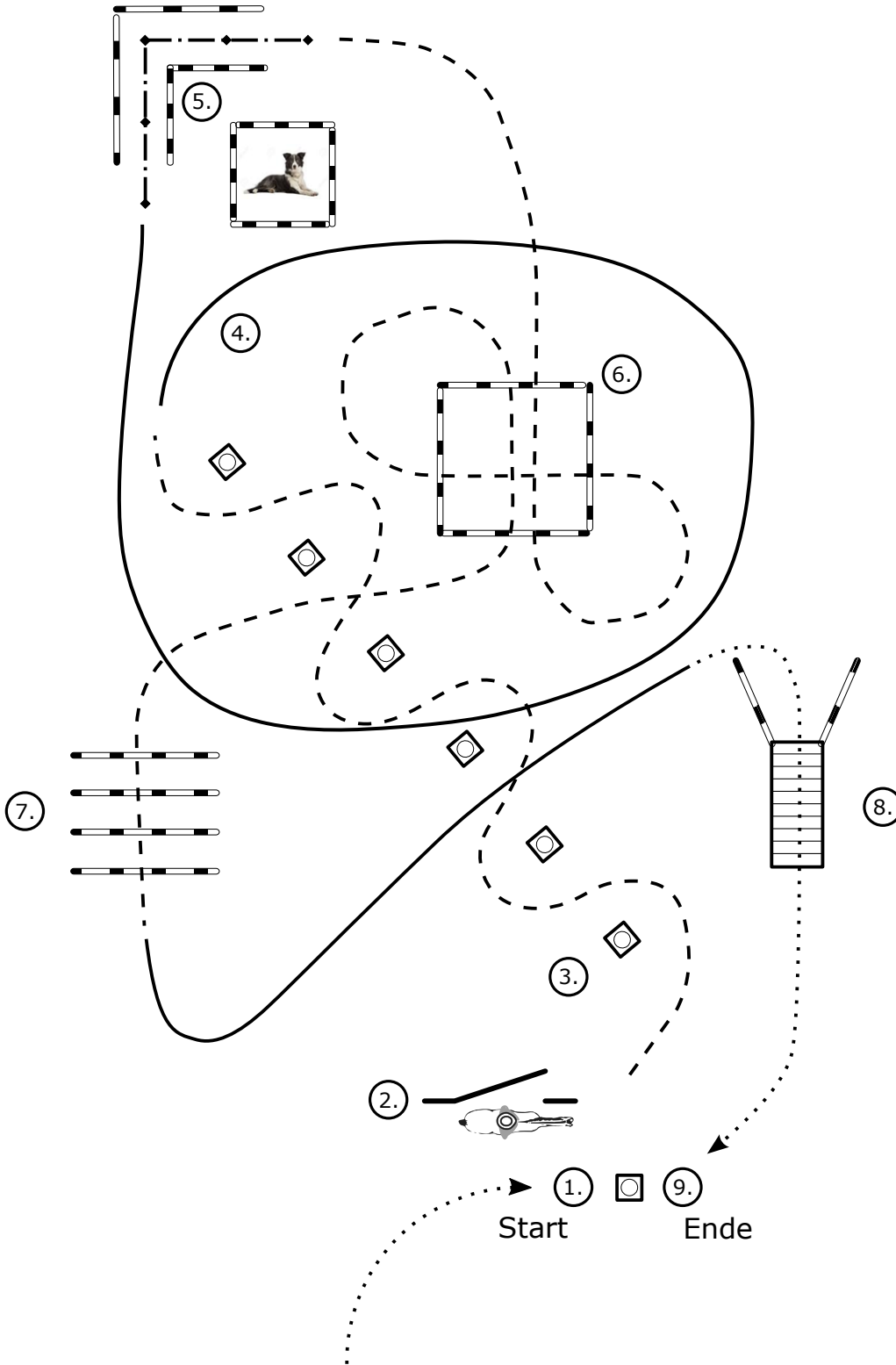

1. Einreiten
Hund ableinen
2. Tor
Hund vorausschicken
3. Trab Slalom
Hund bei Fuß
4. Rechtsgalopp
Hund bei Fuß
5. Rückwärts
Hund vorher im Quadrat ablegen
6. Trabstangen
Hund bei Fuß
(Hund mit durch das Quadrat)
7. Trabstangen
Hund bei Fuß
8. Linksgalopp, Schritt
Brücke
Hund vorausschicken
9. Absteigen
Hund anleinen

- Schritt
- - - - - Trab
- Galopp
- ◆ - - - ◆ Rückwärts

Horse & Dog Trail LK 3-5

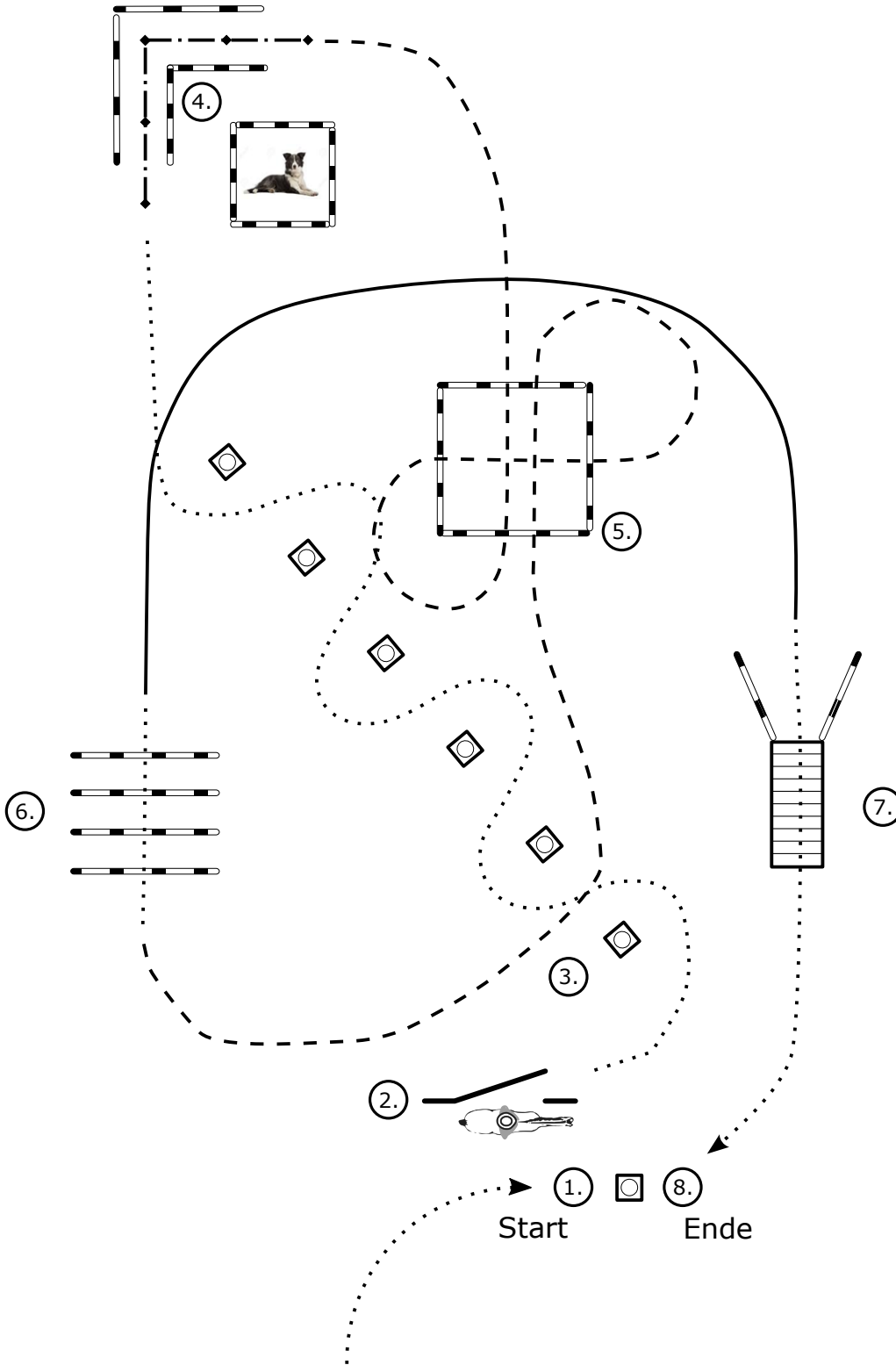

1. Einreiten
Hund ableinen
2. Tor
Hund voraus oder nachholen
3. Schritt Slalom
Hund bei Fuß
4. Rückwärts
Hund vorher im Quadrat ablegen, danach Hund abrufen
5. Trabstangen
Hund bei Fuß (Hund mit durch das Quadrat)
6. Schrittstangen
Hund bei Fuß
7. Rechtsgalopp zur Brücke
Hund bei Fuß, Brücke, Hund voraus oder nachkommen lassen
8. Absteigen
Hund anleinen

- Schritt
- - - - - Trab
- Galopp
- ◊ - - - - ◊ Rückwärts

Ranch Riding

LK 1 A / LK 1 B / LK 2 A / LK 2 B

Qualifikationspattern RR 2017 #6: LK 1/2 A/B sen.
(auch für Hallen und Plätze 20x40m geeignet)

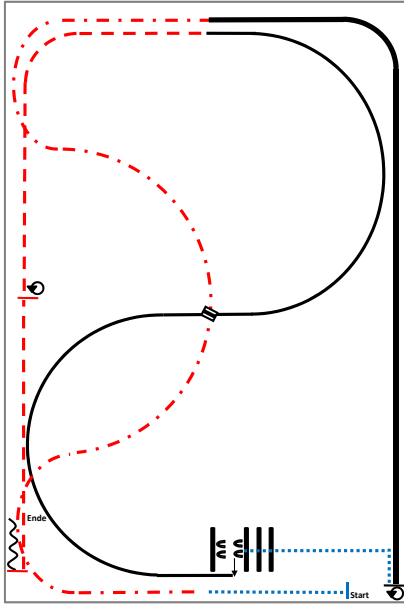

- 1) Walk.
- 2) Extended trot serpentine.
- 3) Extended lope right lead.
- 4) Stop, 180° turn right.
- 5) Walk.
- 6) Walk over, sidepass left.
- 7) Lope right lead.
- 8) Lead change.
- 9) Lope left lead.
- 10) Trot.
- 11) Stop, 360° turns each direction either way first.
- 12) Trot, stop, back.

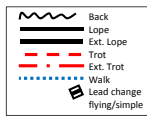

LK 3 A / L 3 B

Pattern RR 2017 #2: LK 3 A/B
(auch für Hallen und Plätze 20x40m geeignet)

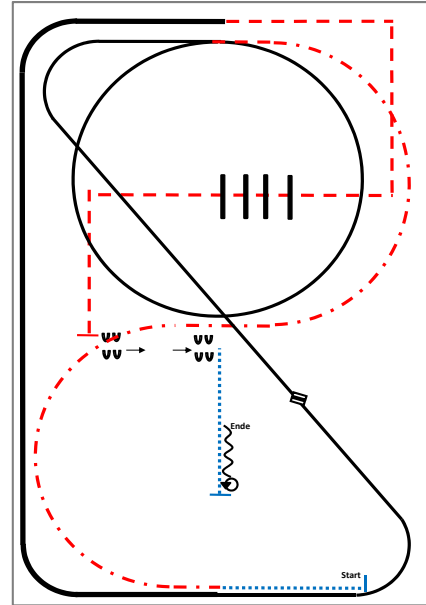

- 1) Walk.
- 2) Extended trot, trot.
- 3) Lope left lead one circle, lope left lead.
- 4) Lead change.
- 5) Lope right lead.
- 6) Extended lope.
- 7) Trot corners.
- 8) Trot over, trot.
- 9) Stop, sidepass left.
- 10) Walk, stop.
- 11) 360° turn right or left, back.

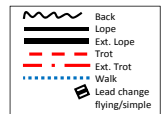

LK 4 A / LK 4 B / LK 5 A / LK 5 B

Pattern RR 2017 #3: LK 4/5 A/B
(auch für Hallen und Plätze 20x40m)

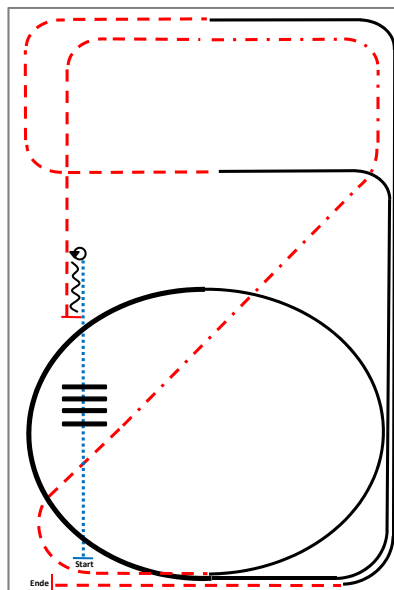

- 1) Walk.
- 2) Walk over, walk.
- 3) Stop, 360° turn left or right.
- 4) Back.
- 5) Trot.
- 6) Extended trot, trot.
- 7) Lope left lead.
- 8) Extended lope, lope.
- 9) Trot.
- 10) Lope right lead.
- 11) Trot, stop.

